

**SYS**·TECH







S I G N A G E T E C H N O L O G Y

Systech Signage Technology

---

# Product Catalog

# Contents:

	Architectural Modular Series
	Modular Window Sign Series
	Poster Holder Series
	Paper Hanger Series
	InfoStrip Series
	Flexa-Frame Series
	Vertex Series
	Magnetic Sign Series
	Cubicle Sign Series
	Dry Erase Board Sign Series
	C Channel Sign Series

# Architectural Modular Series

AM Series - Modular Aluminum Sign System  
Suitable for Interior & Exterior Use

## ARCHITECTURAL MODULAR SERIES

This innovative sign system comprises of three core components: the Base Plate, the Inserts and the Sidelocks.

These may be arranged into a seemingly infinite array of designs with unlimited components, colors, sizes, mounting and graphic options, allowing Architects, Interior Designers and Sign Companies optimal design flexibility.

AM Series components can be arranged into the precisely required configuration, producing signage of outstanding elegance, that is custom designed to suit your fit out, look and feel.

## FEATURES & BENEFITS

- Absolute design flexibility: offers total signage development flexibility.
- Slim and light construction: lightweight and durable aluminum.
- Slimline design (1/4" in depth).
- Simple to use: requires no tools or clip devices to change information.
- Easy to maintain: durable aluminum construction requires no maintenance and is easy to clean.
- Cost reduction on updates: single Inserts can be easily updated without replacing the entire sign.
- Security feature: tamper proof locking option available upon request

## POSSIBLE USES

AM Series signage is designed for use in the widest of interior and exterior, commercial and industrial applications including:

- Door Signs
- Name Plates
- Directories
- Wayfinding
- Meeting Rooms
- Level Indicators
- Personnel
- Honor Boards
- Staff ID
- Cubicle ID
- Office Signage
- Overhead Signs
- Wall Signs

## HOW TO OPERATE

Simply remove either the left or the right Sidelock by pushing it in an upward direction. The Sidelock will release.

Once the Sidelock is removed, slide the Insert of your choice out and off the Base Tracks.

Perform in reverse to replace the Insert. Finally, replace the Sidelock to complete.

## MOUNTING & INSTALLATION

- Wall mount
- Door mount
- Frame or stand
- Glass mounted
- Flag mount
- Desk stand
- Suspended
- Flag bracket – single or double-sided
- Workstation bracket – various
- Double-sided foam tape
- Silicone adhesive & other adhesives
- Concealed screw fixing
- Velcro
- Z-bracket
- Hinged

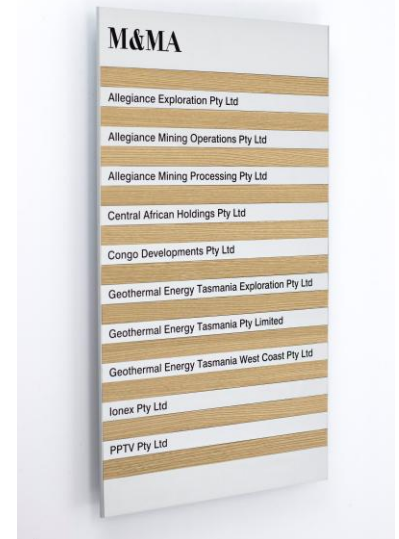
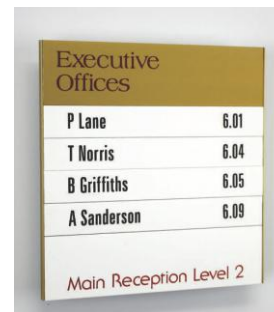
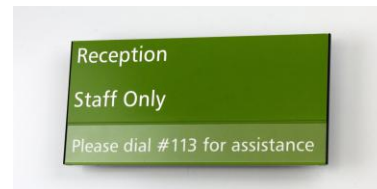
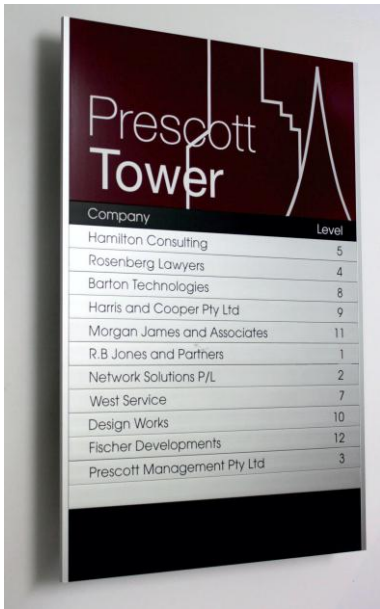
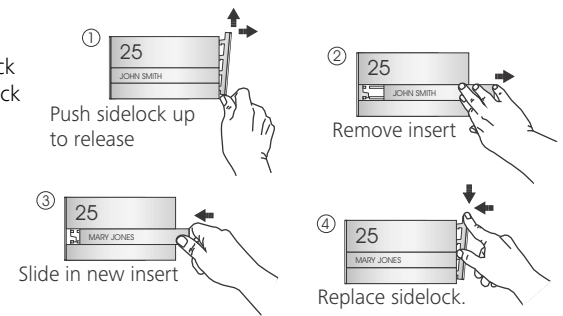

## COMPONENTS

### INSERTS

Aluminum Inserts are offered in a wide range of sizes. They start at 13/16" high and increase in increments of 13/16".

For example - 13/16, 1 5/8", 2 7/16" , 3 1/4", 4 1/8" and so on.

The maximum height for a single Insert is 47 1/8" High. AM Series Inserts have a flat surface onto which your copy and graphics can be applied

### BASE PLATE

All AM Series signs have a Base Plate.

The Base Plate is the backing panel for the sign. It has evenly spaced rails, the Inserts slide onto the Base Plate.

The size of the Base Plate is determined by the width and the number of Inserts on the sign. Systech manufacture the Base Plate to suit the requirements of each individual sign.

### SIDELOCKS

The unique AM Series Sidelock system provides a fast and effective means of fastening the Inserts and Base Plates together as a complete sign. Sidelocks are supplied in pairs. All signs require Sidelocks, one on the left and one on the right.

Foolproof and simple, the AM Series Sidelock is available in 3 profiles: (Standard) 1/16", 1/4" and 1/2". The 1/4" and 1/2" sizes are available with corners square cut or radius cut options.

## FINISH

The standard finish is clear anodized aluminum

Alternative Finishes Include:

- New York Anodized
- Matte Black Anodized
- Matte Gold Anodized
- Painted – Single Pack or 2 Pack
- Mill Finish – suitable for painting

## SIZES

See a full list of sizes on the following page.

## ADA

The Architectural Modular Series is ADA compliant. ADA can be laminated to the face of the Inserts. The Inserts are also able to accept Raster Braille.

## OPTIONAL INSERTS

- Slider Inserts
- These are available in 2 sizes:
- 13/16" High and 1 5/8" High
- Slider Inserts can be used with a clear Lexan cover OR
- A Slider Plate for Vacant /In Use Signs

## COPY OPTIONS

- Vinyl cut graphics
- Digital prints
- ADA - Braille and Tactile graphics
- Silkscreen printing
- Engraving
- 3D lettering

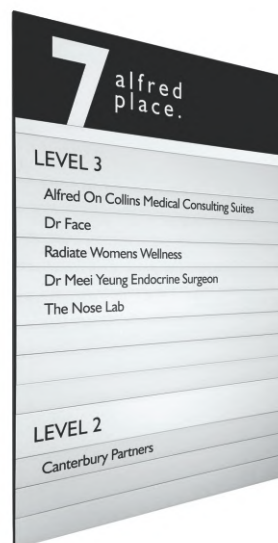
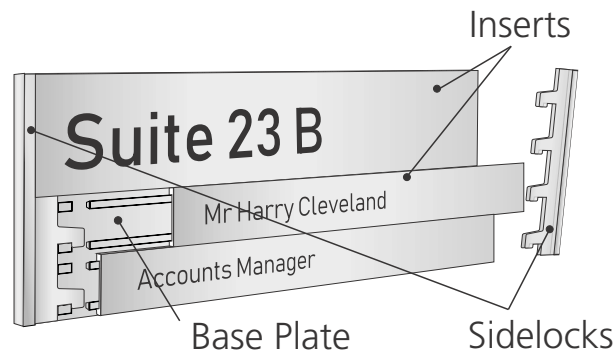

# ARCHITECTURAL MODULAR SERIES

# SIZE CHART

## WIDTH OF INSERTS IN INCHES (excluding Sidelocks)

a	b	c	d	e	f	g	h	j	k	l	m	n	o	p	q	r	s	t	u	v	w	x	y	z
2 1/16	4 1/8	6 3/16	8 1/4	10 5/16	12 3/8	14 7/16	16 1/2	18 9/16	20 5/8	22 11/16	24 3/4	26 13/16	28 7/8	30 15/16	33	35 1/16	37 3/16	39 1/4	41 5/16	43 3/8	45 1/2	47 9/16	49 5/8	51 11/16

aa	ab	ac	ad	ae	af	ag	ah	aj	ak	Maximum Width
53 3/16	55 13/16	57 5/8	59 15/16	62	64 1/2	66 1/8	68 3/16	70 1/4	74 7/16	

## HEIGHT OF INSERTS IN INCHES

Tracks	Inches	Tracks	inches
1	13/16	56	46 1/4
2	1 5/8	57	47 1/8
3	2 7/16	58	47 15/16
4	3 1/4	59	48 3/4
5	4 1/8	60	49 5/8
6	4 15/16	61	50 7/16
7	5 3/4	62	51 1/4
8	6 5/8	63	52 1/16
9	7 7/16	64	52 15/16
10	8 1/4	65	53 3/4
11	9 1/16	66	54 9/16
12	9 15/16	67	55 3/8
13	10 3/4	68	56 1/4
14	11 9/16	69	57 1/16
15	12 3/8	70	57 7/8
16	13 3/16	71	58 11/16
17	14 1/16	72	59 1/2
18	15	73	60 3/8
19	15 13/16	74	61 3/16
20	16 1/2	75	62
21	17 7/16	76	62 13/16
22	18 1/4	77	63 11/16
23	19 1/16	78	64 1/2
24	19 15/16	79	65 5/16
25	20 5/8	80	66 1/8
26	21 1/2	81	66 15/16
27	22 5/16	82	67 13/16
28	23 1/8	83	68 5/8
29	23 15/16	84	69 7/16
30	24 3/4	85	70 1/4
31	25 5/8	86	71 1/8
32	26 7/16	87	71 15/16
33	27 1/4	88	72 3/4
34	28 1/8	89	73 9/16
35	28 7/8	90	74 7/16
36	29 3/4		
37	30 9/16		
38	31 3/8		
39	32 3/16		
40	33		
41	33 13/16		
42	34 3/4		
43	35 9/16		
44	36 3/8		
45	37 3/16		
46	38 1/16		
47	38 7/8		
48	39 11/16		
49	40 1/2		
50	41 5/16		
51	42 1/8		
52	43		
53	43 13/16		
54	44 5/8		
55	45 1/2		

Maximum Height

### Widths

The smallest modular size is 2 1/16" Wide.  
 Sizes increase in 2 1/16" sections up to a maximum of approx. 74" - See Above.

### Heights

The smallest insert is 13/16".  
 Sizes increase from there in multiples of 13/16".  
 Single panels/ inserts are available in a max height of 47 1/8".  
 All Inserts must however be a multiple of 13/16" in order to fit on the base tracks.

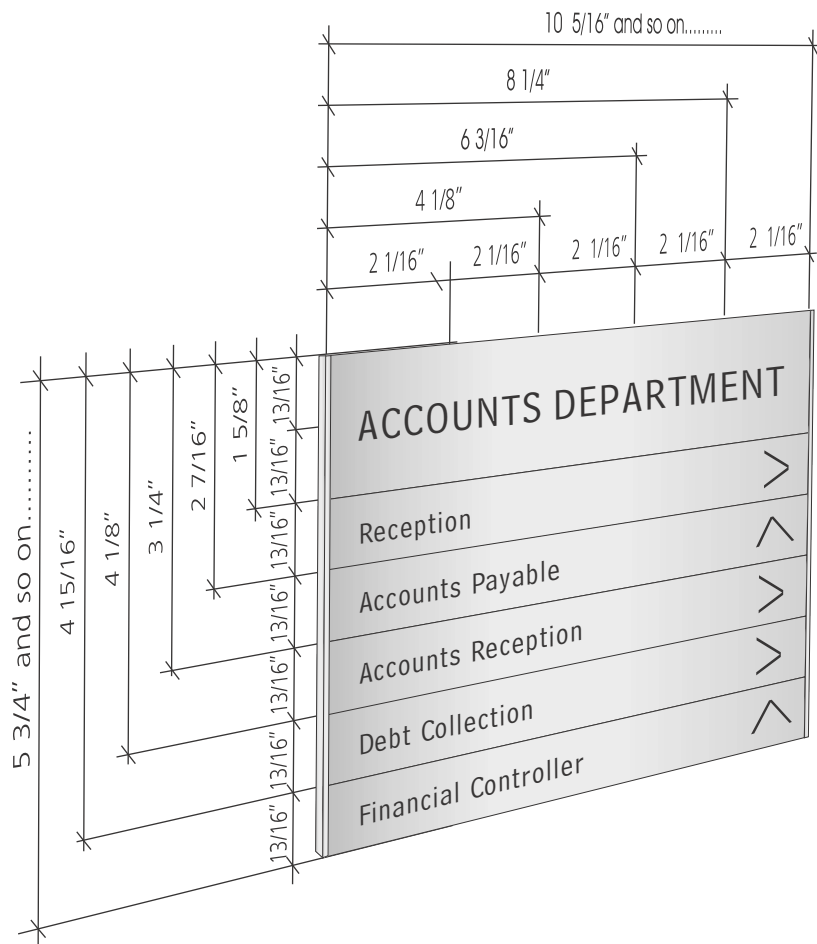

# Modular Window Sign Series

Window Signs for updatable paper inserts

## THE MODULAR WINDOW SIGN

The Modular Window Sign Series is a modular sign system tailored to meet the requirements of individual customers. They are designed to provide an efficient and effective means of displaying and interchanging graphic information with minimal investment of time or resources.

Computer generated copy and graphics can be produced quickly and easily by the user, enabling signage to be amended or updated whenever required.

Due to the slim profile, the Modular Window Sign can be integrated with our other system, the Architectural Modular Series. Combining the two systems enables the introduction of Headers, Footers and side panels thus adding further options to your signage design and layout.

## HOW THE MODULAR WINDOW SIGN WORKS

The Modular Window Sign consists of an aluminum backing panel that forms a C channel, a non-glare acrylic cover and flexible End Caps. The Modular Window Sign Series is extremely easy to use, requiring no tools or clip devices to change graphic information.

## HOW TO OPERATE

Simply slide the acrylic cover to one side, approximately halfway out of the unit; the flexible End Cap will simultaneously open. Remove and replace the paper insert by sliding it under the acrylic cover, then slide the acrylic back into its original position.

The End Cap will spring back into place firmly securing the entire unit.

NOTE: The Modular Window Sign Series is suitable for interior use only as it is not water proof.

## OPTIONAL INSERTS INCLUDE:

- Lightweight cardboard
- Clear Lexan
- Photographic Material

Only one piece of paper can be inserted at a time; do not attempt to insert multiple sheets.

NOTE: Please contact Systech if lightweight cardboard or photographic material is to be used. These units require modification for these materials during manufacture.

8½" x 11" Modular Window Sign with a Header and Footer

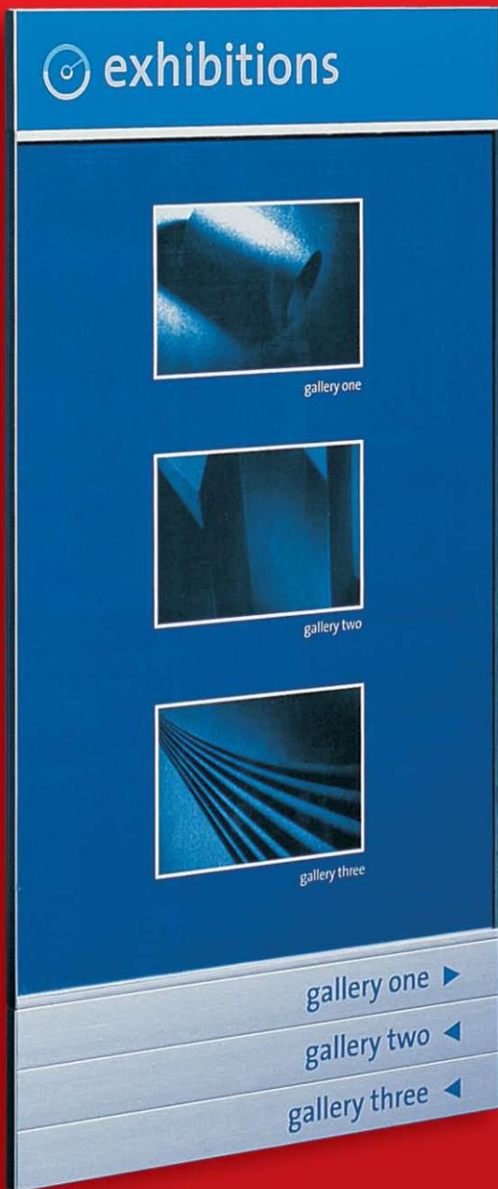

D3 Modular Window Sign



B2.3 Modular Window Sign



B3 Modular Window Sign



C4 Modular Window Sign with AM Series sign on left hand side

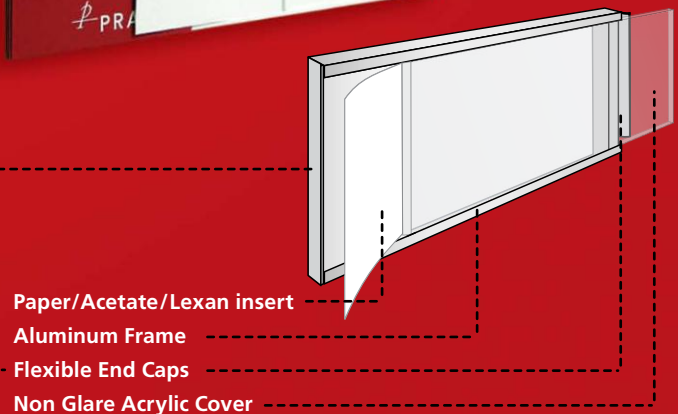

Paper/Acetate/Lexan insert

Aluminum Frame

Flexible End Caps

Non Glare Acrylic Cover



## LETTER AND HALF LETTER SIZES

**MWS LS-P**  
8½"× 11"



**MWS LS-L**  
11"× 8½"

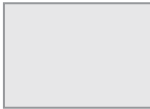

**MWS LS.5-P**  
4¼"× 5½"



**MWS LS.5-L**  
5½"× 4¼"



**MWS 2LS-P**  
Header 8½"× 1 ⅝"  
Window 8½"× 11"



**MWS 2LS-L**  
Header 11"× 1 ⅝"  
Window 11"× 8½"



### NOTE:

These dimensions are the paper sizes, the overall dimensions of the signs are larger.

Please contact Systech for more detail.

The above units are designed to suit standard paper sizes.

The overall dimensions of the above units are larger than the sizes listed.

For sizes larger than 8½"× 11" , please refer to the Poster Holder Series by Systech .

8½"× 11" Modular Window Sign with 1⅝"Footer with Slider Insert and Slider Plate



8½"× 11" Modular Window Sign open



## POSSIBLE USES

- Meetings, conferences, timing, or dates
- Staff identification
- Schedules
- Evacuation procedures
- Internal distributions information
- Cubicle and Workstation identification
- Opening hours
- Hospital / patient identification
- Name plates
- Instructions
- Menus
- Price lists
- Phone extension lists
- Staff notices

## COLOR & DESIGN

In standard format Modular Window Signs are available in Satin Natural Anodized finish. The flexible End Caps are matte gray plastic these are designed to coordinate with the Satin Natural Finish.

The aluminum section of the unit can be painted to your preferred color. All painting must be completed in house by Systech prior to assembly in order to maintain quality standards. Please specify a PMS code for color matching. End Caps should only be painted if they will not be opened regularly as paint will wear with frequent use.

## MOUNTING & INSTALLATION OPTIONS

- Double sided foam tape
- Silicon adhesive
- Counter sink screw fixing
- Velcro
- Z Brackets - Letter size only.
- Desk stand
- Cubicle Screen Bracket - Various

These options are subject to the size and the weight of the unit.

## ORDERING OR SPECIFYING

To order or specify the Modular Window Sign please include the following:

- Quote the code of one of the standard units in this brochure  
OR
- For a design of your choice, please nominate the following items:
  - AM Series Header (if required)
  - Size and code of Modular Window Sign (see standard sizes on Pg 4)
  - AM Series Footer (if required)

8½"× 11" Modular Window Sign

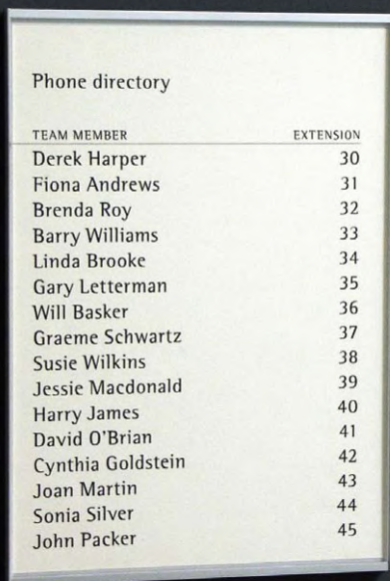

Colored paper insert

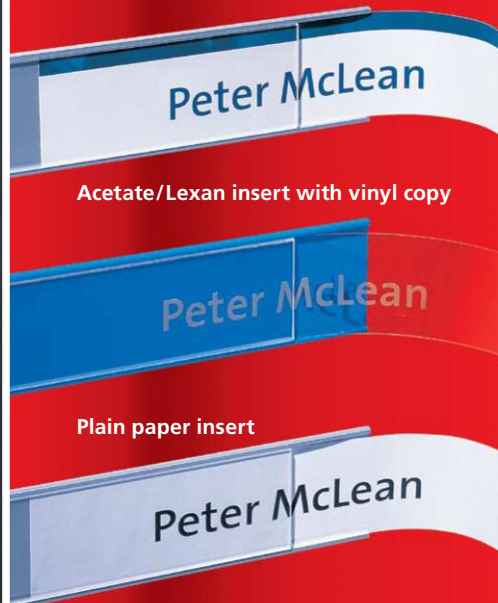

Acetate/Lexan insert with vinyl copy

Plain paper insert

## MODULAR WINDOW SIGN - STANDARD SIZES

**B** 4 1/8"

B3 4 1/8" x 2 7/16"	B4 4 1/8" x 3 1/4"	B5 4 1/8" x 4 1/8"	B6 4 1/8" x 4 15/16"

**C** 6 3/16"

C3 6 3/16" x 2 7/16"	C4 6 3/16" x 3 1/4"	C5 6 3/16" x 4 1/8"	C6 6 3/16" x 4 15/16"

**D** 8 1/4"

D3 8 1/4" x 2 7/16"	D3/S 8 1/4" x 2 7/16"	D4 8 1/4" x 3 1/4"	D5 8 1/4" x 4 1/8"	D6 8 1/4" x 4 15/16"

**E** 10 5/16"

E3 10 5/16" x 2 7/16"	E3/S 10 5/16" x 2 7/16"	E4 10 5/16" x 3 1/4"	E5 10 5/16" x 4 1/8"	E6 10 5/16" x 4 15/16"

## MODULAR WINDOW SIGNS WITH AM SERIES HEADERS

**B** 4 1/8"

B1.3 4 1/8" x 13/16"	B2.3 4 1/8" x 1 5/8"	B1.4 4 1/8" x 13/16"	B2.4 4 1/8" x 1 5/8"	B1.5 4 1/8" x 13/16"	B2.5 4 1/8" x 1 5/8"	B2.6 4 1/8" x 1 5/8"
W 4 1/8" x 2 7/16"	W 4 1/8" x 2 7/16"	W 4 1/8" x 3 1/4"	W 4 1/8" x 3 1/4"	W 4 1/8" x 4 1/8"	W 4 1/8" x 4 1/8"	W 4 1/8" x 4 15/16"

**C** 6 3/16"

C1.3 6 3/16" x 13/16"	C2.3 6 3/16" x 1 5/8"	C2.4 6 3/16" x 1 5/8"	C3.3 6 3/16" x 2 7/16"	C2.5 6 3/16" x 1 5/8"
W 6 3/16" x 2 7/16"	W 6 3/16" x 2 7/16"	W 6 3/16" x 3 1/4"	W 6 3/16" x 2 7/16"	W 6 3/16" x 4 1/8"

**D** 8 1/4"

D2.3 8 1/4" x 1 5/8"	D2.3/S 8 1/4" x 1 5/8"	D2.4 8 1/4" x 1 5/8"	D2.5 8 1/4" x 1 5/8"	D2.6 8 1/4" x 1 5/8"
W 8 1/4" x 2 7/16"	W 8 1/4" x 2 7/16"	W 8 1/4" x 3 1/4"	W 8 1/4" x 4 1/8"	W 8 1/4" x 4 15/16"

**E** 10 5/16"

E2.3 10 5/16" x 1 5/8"	E2.3/S 10 5/16" x 1 5/8"	E2.4 10 5/16" x 1 5/8"	E2.5 10 5/16" x 1 5/8"
W 10 5/16" x 2 7/16"	W 10 5/16" x 2 7/16"	W 10 5/16" x 3 1/4"	W 10 5/16" x 4 1/8"

- The above diagrams are indicative of the selection of options available. There are many more options possible, please contact us with your preferred design.
- Width Increments are multiples of 2 7/16"  
Height Increments are multiples of 13/16" Approx.
- Smallest Size available is 4 1/8" Wide X 2 7/16" High.  
Largest Size available is Letter Size – See page three for details.
- Please add 1/8" to the overall width of the above sizes. This allows for Sidelocks and/or End Caps.  
Actual paper sizes will be different to sign sizes.
- For sizes Letter Size or larger, please refer to our Poster Holder Series.

Sign Code: C3.3

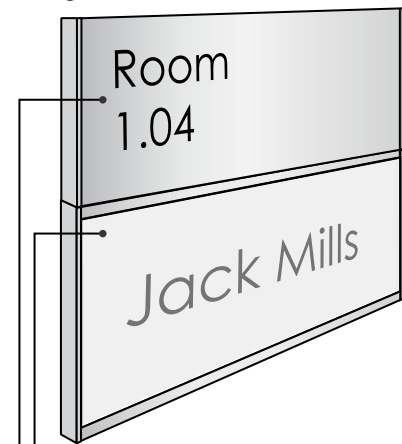

**AM Series Header**  
6 3/16" Wide (C) x 2 7/16" High (3)  
**MWS Window**  
6 3/16" Wide (C) x 2 7/16" High (3)

## PRODUCT QUALITY

At Systech, our reputation has been built upon the manufacture of products of exceptional quality. In keeping with this policy, the Modular Window Sign Series has been developed to meet the highest standard specifications at a realistic cost.

Materials of superior quality are used in the manufacture of each unit to ensure maximum usage over an extended period of time. Whilst quality is of paramount importance, we believe that customers need choice.

That is why we offer an extensive range of sizes, each designed with the customers needs in mind. Systech is committed to the continued development of its product range.

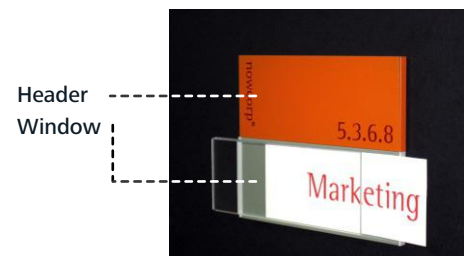

Header  
Window

## AM SERIES FOOTERS

Modular Window Signs with AM Series Footers are also available. Please let us know your preferred layout.

# Poster Holder Series

Slimline Poster Framing system, easy changover or  
copy and graphics



Poster Holders are available in standard and custom sizes.

The clean-line design is perfect for interior applications.

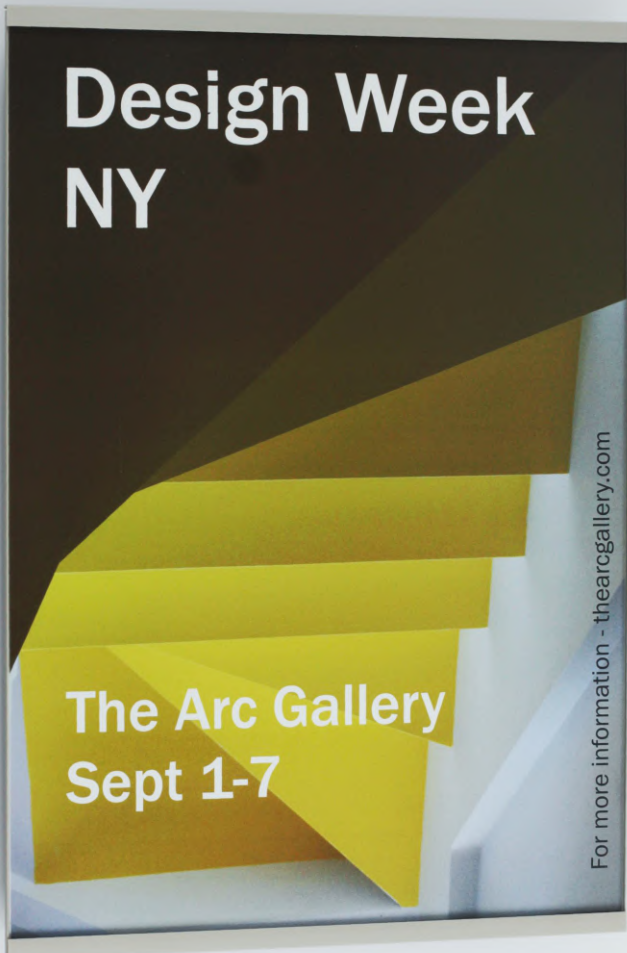

## THE POSTER HOLDER

The Poster Holder Series is a modular graphic display system tailored to meet the requirements of individual customers. They are designed to provide an efficient and effective means of displaying and interchanging graphic information or posters with minimal investment of time and resources.

Posters and computer generated graphics can be produced quickly and easily by the user, enabling inserts to be amended or updated whenever required. Due to the slim profile, the Poster Holder can be integrated with our other system, the Architectural Modular Series. Combining the systems enables the introduction of headers footers or a directory board, thus adding another dimension to your signage options. For information on the Architectural Modular Series, please contact Systech.

## SIMPLE DESIGN

The Poster Holder consists of an aluminum backing panel, a gray U channel frame at the top and the bottom, a clear non-glare acrylic cover and gray End Caps.

To change posters, simply lift the acrylic cover off and remove the existing insert. Place the new insert in behind the poster clips and replace the acrylic cover.

As these units are top opening, you must allow a 1" clearance for access. A tamper proof option is also available upon request.

## OPTIONAL INSERTS INCLUDE:

- Paper - white or colored
- Lightweight cardboard
- Clear acetate/lexan
- Photographic material

Only one piece of paper can be used at a time. Do not attempt to insert multiple sheets.

## POSSIBLE USES

- Meetings or conferences; timing or dates
- Promotional Material
- Schedules
- Evacuation procedures
- Internal distribution information
- Opening hours
- Hospital/Patient Information
- Instructions
- Menus
- Price lists
- Phone extension lists
- Staff Notices

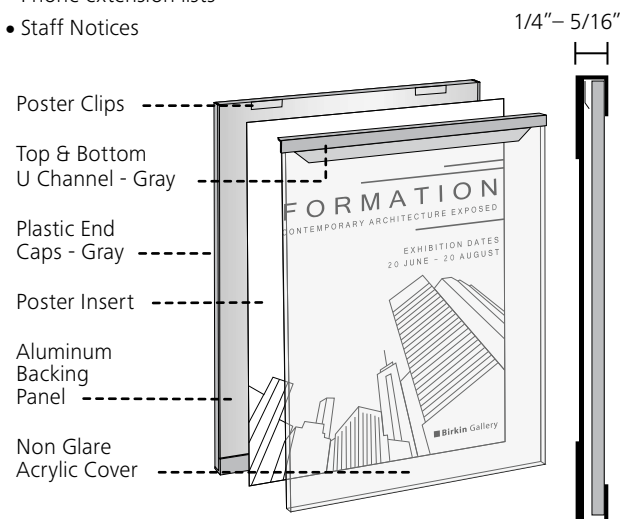

## COLOR & DESIGN

The Poster Holder is available in a gray finish.  
The End Caps are also flexible matte gray plastic.  
The Poster Holder frame and End Caps can be painted to your preferred color.  
In order to maintain quality standards, this must be done in house by Systech. Please specify your PMS for color matching.

## SIZES

The Poster Holder is designed to accommodate larger graphic material.

Standard Sizes available are: • 8½"×11" • 8 ½"×14" • 11"×17" • 24"×36"  
We offer any custom size within the above sizes.

Both Portrait and Landscape orientations are available.  
Please specify which orientation you require.

For a list of standard sizes, see page 4.

## CUSTOM SIZES

The Poster Holder is available in any custom size between 8 1/2" x 11" and 24" x 36"  
For non standard sizes, please specify one of the following:

- The paper size you wish to insert
- The outside to outside dimensions for the entire unit

There are no penalties for custom sizes. The AM Series headers, footers or side mounted directories can be combined with the Poster Holder; the maximum height of a header is 1 5/8" high.  
There are no limitations in size for footers or directories mounted to the side or below the Poster Holder.

## MOUNTING/INSTALLATION OPTIONS

We suggest:

- Doubled stick tape and/or
- Silicone adhesive
- Counter sink screw fixing
- Velcro
- Z Brackets
- Desk Stand

These options are subject to size and weight of the unit.  
Client to specify.

## ORDERING & SPECIFYING

To order or specify the Poster Holder Series please Include one of the following:

Quote the code of one of the standard units in this brochure on page 4.

OR

If the option you would like is not illustrated please nominate the following items:

- AM Series Header (if required)
- Size of desired Poster Holder (See sizes on page 4)
- AM Series Footer (if required) AM Series Directory (if required)

For custom sizes please refer to the information above in the section "CUSTOM SIZES"

NOTE: The Poster Holder Series is only suitable for interior use as it is not waterproof.

Poster inserts can be changed with ease



Poster Holders can be combined with the Systech Architectural Modular Series

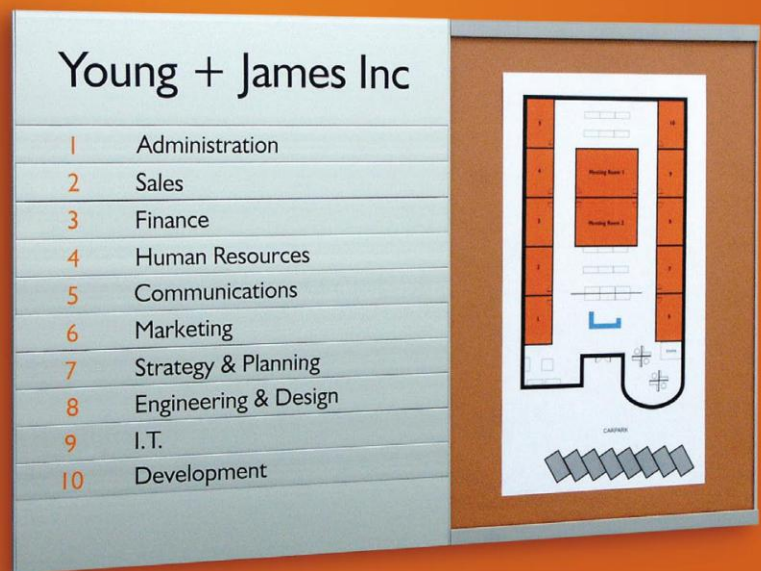

Portrait and landscape orientation are available



# POSTER HOLDER SERIES - SIZES

## LETTER SIZE

	PH LS-P	PH LS-L	PH 2LS-P	PH 2LS-L
Header			8 $\frac{5}{8}$ " x 1 $\frac{5}{8}$ "	11 $\frac{1}{8}$ " x 1 $\frac{5}{8}$ "
Poster Holder	8 $\frac{1}{8}$ " x 11 $\frac{9}{16}$ "	11 $\frac{1}{8}$ " x 8 $\frac{9}{16}$ "	8 $\frac{5}{8}$ " x 11 $\frac{9}{16}$ "	11 $\frac{1}{8}$ " x 9 $\frac{1}{16}$ "
Paper	8 $\frac{1}{2}$ " x 11"	11" x 8 $\frac{1}{2}$ "	8 $\frac{1}{2}$ " x 11"	11" x 8 $\frac{1}{2}$ "

## PORTRAIT ORIENTATION

	PH LS-P	PH 1-P	PH 2-P	PH 3-P
Poster Holder	8 $\frac{5}{8}$ " x 11 $\frac{9}{16}$ "	8 $\frac{1}{8}$ " x 14 $\frac{9}{16}$ "	11 $\frac{1}{8}$ " x 17 $\frac{9}{16}$ "	24 $\frac{1}{8}$ " x 36 $\frac{9}{16}$ "
Paper	8 $\frac{1}{2}$ " x 11"	8 $\frac{1}{2}$ " x 14"	11" x 17"	24" x 36"

## LANDSCAPE ORIENTATION

	PHLS-L	PH 1-L	PH 2-L	PH 3-L
Poster Holder	11 $\frac{1}{8}$ " x 9 $\frac{1}{16}$ "	14 $\frac{1}{8}$ " x 9 $\frac{1}{16}$ "	17 $\frac{1}{8}$ " x 11 $\frac{1}{16}$ "	36 $\frac{1}{8}$ " x 24 $\frac{1}{16}$ "
Paper	11 x 8 $\frac{1}{2}$ "	14 x 8 $\frac{1}{2}$ "	17 x 11"	36" x 24"

## PORTRAIT ORIENTATION WITH AM SERIES HEADERS

	PH 2LS-P	PH 2-1-P	PH 2-2-P	PH 2-3-P
Header	8 $\frac{5}{8}$ " x 1 $\frac{5}{8}$ "	8 $\frac{5}{8}$ " x 1 $\frac{5}{8}$ "	11 $\frac{1}{8}$ " x 1 $\frac{5}{8}$ "	24 $\frac{1}{8}$ " x 1 $\frac{5}{8}$ "
Poster Holder	8 $\frac{5}{8}$ " x 11 $\frac{9}{16}$ "	8 $\frac{5}{8}$ " x 14 $\frac{9}{16}$ "	11 $\frac{1}{8}$ " x 17 $\frac{9}{16}$ "	24 $\frac{1}{8}$ " x 36 $\frac{9}{16}$ "
Paper	8 $\frac{1}{2}$ " x 11"	8 $\frac{1}{2}$ " x 14"	11" x 17"	24" x 36"

## LANDSCAPE WITH AM SERIES HEADERS

	PH 2LS-L	PH 2-1-L	PH 2-2-L	PH 2-3-L
Header	11 $\frac{1}{8}$ " x 1 $\frac{5}{8}$ "	14 $\frac{1}{8}$ " x 1 $\frac{5}{8}$ "	17 $\frac{1}{8}$ " x 1 $\frac{5}{8}$ "	36 $\frac{1}{8}$ " x 1 $\frac{5}{8}$ "
Poster Holder	11 $\frac{1}{8}$ " x 9 $\frac{1}{16}$ "	14 $\frac{1}{8}$ " x 9 $\frac{1}{16}$ "	17 $\frac{1}{8}$ " x 11 $\frac{1}{16}$ "	36 $\frac{1}{8}$ " x 24 $\frac{1}{16}$ "
Paper	11" x 8 $\frac{1}{2}$ "	14" x 8 $\frac{1}{2}$ "	17" x 11"	36" x 24"

## AM SERIES FOOTERS

AM Series Footers are also possible, simply email your desired layout or combination through to Systech.

## CUSTOM SIZES

The above diagrams are only a selection of the options available. Please contact us with details of your alternative designs.

Please advise the overall size you require, or provide the paper size you wish to accommodate.

## FEATURES & BENEFITS

- The Poster Holder is a top opening unit
- Extremely easy to use
- Perfect for frequent graphic changes
- No tools or clips required to change graphics
- There is a security mechanism available in the form of a small grub screw; this will help secure the unit when higher security is required.

## PRODUCT ORIENTATION WHEN INSTALLING

Poster Holders must be used in the orientation as ordered.

Do not turn a unit on its side to change orientation.

The Poster Holder is top opening, it cannot be laid on its side. The cover will fall off which may result in damage.

## PRODUCT QUALITY

At Systech, our reputation has been built upon the manufacture of products of exceptional quality. In keeping with this policy, the Poster Holder Series has been developed to meet the highest standard specifications at a realistic cost.

Materials of superior quality are used in the manufacture of each unit to ensure maximum usage over an extended period of time.

Whilst quality is of paramount importance, we believe that customers need choice. That is why we have an extensive range of product sizes, each designed with the customers needs in mind.

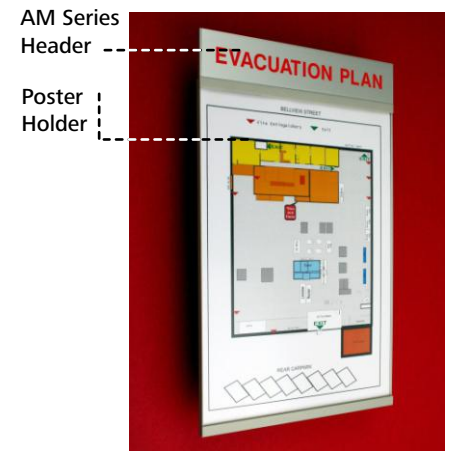

Poster Holders with Footers are also available. Please let us know what layout you require.

# Paper Hanger Series

Paper gripper extrusion for messages, notes and displays

## PAPER HANGER SERIES

Based on the 'gravity' principle, the Paper Hanger Series utilizes an aluminum extrusion with internal rods that grip and hang paper for display purposes.

The Paper Hanger Series is ideal for notes, messages, architectural plans, displays, posters or boardroom presentations.

It can be attached using double-sided foam tape directly to a wall, workstation or any other flat surface.

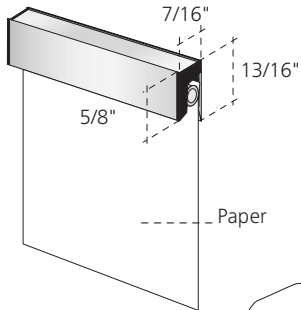

Registered Design

## HOW TO OPERATE

Paper is easily inserted behind the PaperHanger's aluminum rods and is gripped in place through gravity and the grooved surface within the extrusion.

To remove, take the bottom of the paper and lift it up and away from the wall or substrate. Alternatively, slide the paper out sideways to the left or the right. Designed to accept only one piece of paper at a time.

The Paper Hanger can also be used with the Architectural Modular Series. The Paper Hanger's 13/16" high extrusion allows for it to be simply attached to the Architectural Modular Series' 13/16" high Insert with the use of double-stick tape.

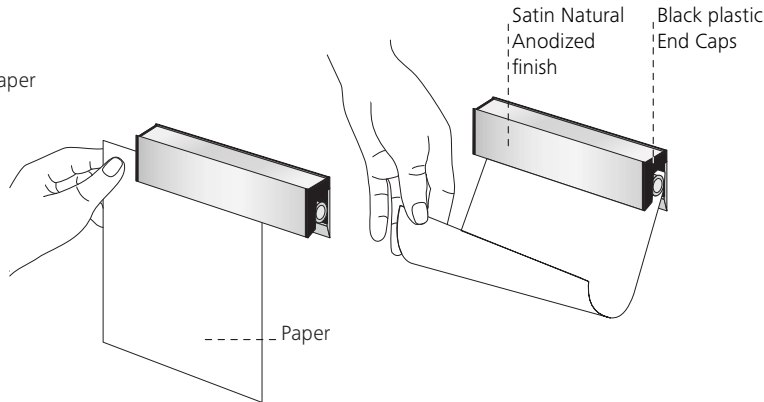

## SIZE DETAILS

The Paper Hanger Series is available in lengths up to 74" and can be cut to any size. Longer lengths may be achieved by removing the End Caps and butt-joining 2 or more lengths together. End Caps are only required on the extreme left and right of the Paper Hanger.

## FINISH

- The standard finish is Satin Natural Anodized aluminum.
- The End Caps are black plastic.

## INSTALLATION

The Paper Hanger can be installed with double-sided foam tape.

## POSSIBLE USES

- Staff notices
- Messages
- Schedules
- Notes
- Opening hours
- Hospital / Patient Identification
- Instructions
- Menus
- Price lists
- Phone extension lists

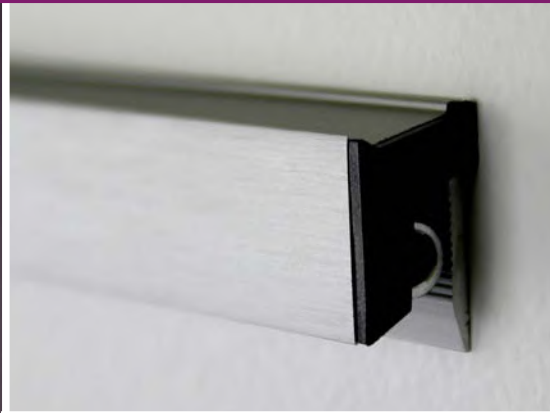



# InfoStrip Series

C Channel 5/8" labeling extrusion  
- Ideal for Pigeon Holes, shelves, drawers

## INFOSTRIP SERIES

InfoStrip is a ticket strip extrusion that is suitable for labeling shelves, drawers, pigeon holes, cubby holes, filing cabinets, display cabinets and much more.

It can be used with a paper insert alone or with a lexan cover and a paper insert combined for a more professional finish.

InfoStrip is suitable for interior use only, as it is not water tight.

## FINISH

- The standard finish is Satin Natural Anodized aluminum (clear anodized).

InfoStrip can be painted if required. A suitable undercoat must be used to prime.

## INSTALLATION

InfoStrip is easily installed with double-stick tape.

## SIZES

- InfoStrip is available in one size - a height of 5/8"
- Maximum length available is 78"
- InfoStrip can be cut to any size by Systech
- InfoStrip can be purchased in full lengths

## OPTIONAL INSERTS

- Paper—white or colored
- Clear cover - Systech offers acetate/lexan maximum length available is 39"

## POSSIBLE USES

- Shelf labels
- Pigeon hole labels
- Drawer labels
- Staff ID
- Product labels
- Workstation identification
- Hospital/patient Identification
- Name plates
- Personnel ID
- Cubby hole labels

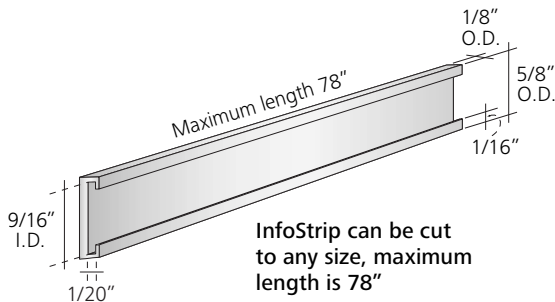

InfoStrip can be cut to any size, maximum length is 78"

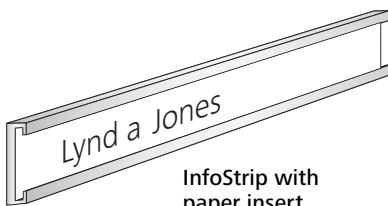

InfoStrip with paper insert

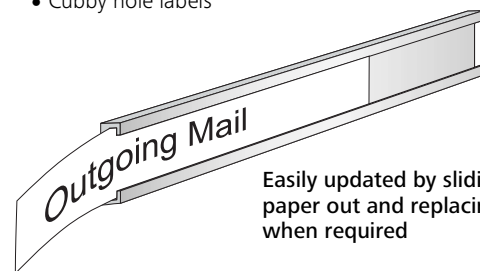

Easily updated by sliding paper out and replacing when required

I.D.



# Flexa-Frame Series

Aluminum frame with clear removable cover  
- Simple display system for paper signage and graphics

## FLEXA FRAME SERIES

Flexa-Frame is a simple framing system that allows the user to print and change copy or graphics as often as needed. Flexa-Frame is an aluminum frame with a powder coated finish. It includes a flexible clear polycarbonate cover which is easily removed with the aid of a suction cup.

An efficient and effective means of displaying and interchanging graphic information. Flexa-Frame requires minimal investment of time or resources by the user. This system enables signage to be amended or updated both quickly and easily with minimal cost.

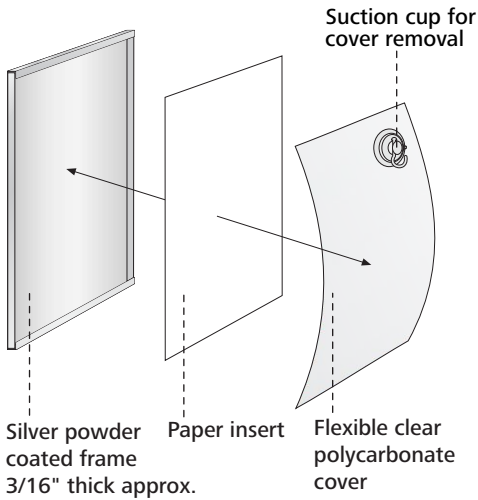

## FINISH

The standard finish is powder coated aluminum

- Color - Silver

## INSTALLATION

Flexa-Frame can be installed using double sided tape or screw fixed.

The units are available with or without countersunk holes.

## SIZES

Flexa-Frame is available in the following sizes

- Letter Size - Portrait and Landscape  
Fits Paper Size 8.5" X 11"  
Overall dimensions of frame slightly larger
- 6" X 6" Frame Size
- 8" X 8" Frame Size

## HOW TO OPERATE

Simply remove the clear flexible cover with a suction cup, change or insert paper and replace cover.

Flexa-Frame is suitable for interior use only. It is not water tight.

## OPTIONAL INSERTS

- Paper—white or colored
- Clear acetate / lexan
- Photographic material
- Any flexible material—maximum thickness 0.07" (if used without clear cover)
- Designed to accept a single piece at a time

## POSSIBLE USES

- Staff Identification
- Schedules
- Evacuation procedures
- Internal distribution memos
- Workstation Identification
- Meetings or conferences; timing or dates
- Opening hours
- Hospital / Patient Identification
- Name plates
- Instructions
- Menus
- Price lists
- Phone extension lists
- Staff Notices
- Room Identification

Registered Design



# Vertex Sign Series

Flexible Frame System for custom Panel Inserts  
- Wall, Ceiling, Projecting Mount Options

## VERTEX SERIES

The Vertex Series is a simple ceiling suspended or wall mounted sign system. It is designed to be lighter and easier to update than other systems of its kind.

Vertex Series can accept a range of insert panels, thus offering you more choice with your design and graphic options.

The aluminum frame is designed to accept a variety of sheet materials that can be changed over, if and when desired.

The flexible End Caps make it simple to slide the sheet material in and out of the frame.

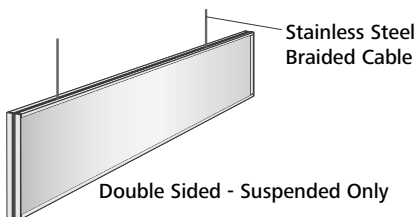
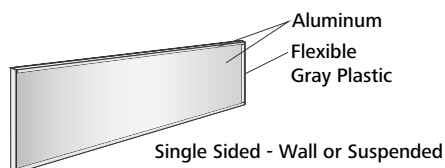

Slide your selected panel material into the frame/channel with completed graphics.

## FINISHES

- Frame - Standard finish clear anodized aluminum.
- End Caps - Gray (Flexible Plastic)
- Painting - Both the frame and the End Caps can be painted if required.

## INSTALLATION

- The Vertex Series is supplied with stainless steel braided wire. Ceiling fixings are not included.
- Method of attachment to ceiling to be advised by sign installer. Various connectors are available.
- Vertex Series can be wall mounted if desired. Please advise if suspension wires are not required.

## HOW TO OPERATE

To change the inserts over, just slide the panel out to one side and the End Cap will flex open enabling removal.

Repeat in reverse to re-insert the new panel.

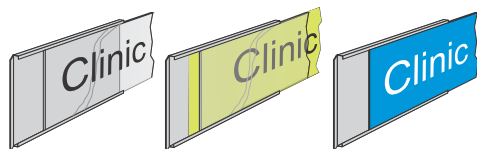

Slide Insert to one side to remove.

## SIZES

Vertex Series is available in the following sizes:

### Channel Height Options:

- 3 1/2", 4", 5", 6", 7"

### Channel Width Options:

- 17", 20", 22", 25", 30", 35", 43", 51", 60".
- Multiple Inserts - just add as many channel sections as you require.

## OPTIONAL INSERT PANELS

- Aluminum Plate Max 3/32" thick (Supplied By Systech)
- Clear Acrylic Max 3/32" thick (Supplied By Systech)
- Colored Acrylic Max 3/32" thick (By Installer)
- ACM Sheet Max 3/32" thick (By Installer)
- Stainless Steel Max 3/32" thick (By Installer)
- Or any other sheet material of above thickness

## POSSIBLE USES

- Wayfinding
- Area Identification
- Directional Signs
- Door Signs
- Public Information
- Corporate or Retail Signage

### Choose Your Preferred Panel Material

- Vertex Series can be:
  - Wall mounted
  - Suspended (hanging - either single or double sided)
  - Flag mounted (projecting)



Wall Mount



Aluminum Panel Insert



Clear Acrylic Panel Insert



Colored Acrylic Panel Insert



Hanging Mount



Flag / Projecting Mount

# Magnetic Sign Series

Magnetic Modular Interior Sign System

- Wayfinding, Room ID, Nameplates, Directories,

## MAGNETIC SIGN SERIES

The Magnetic Sign Series is a slimline interchangeable sign system with aluminum Inserts. The Inserts can be easily removed and replaced as needed.

Choose single or multiple Inserts on each sign.

Magnetic Signs accept removable aluminum Inserts onto which you can apply your copy or graphics.

The panels can be easily removed from within the frame using the custom removal tool provided.

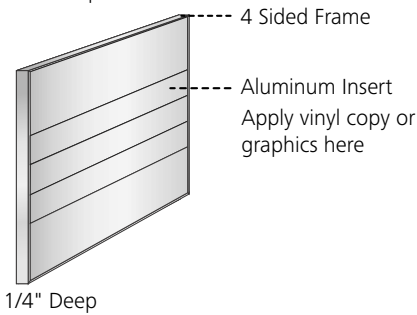
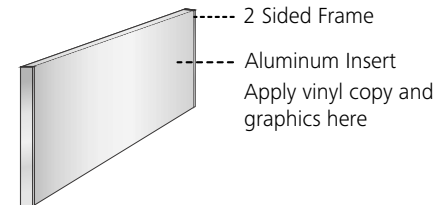

## FINISH

- Frame - Clear anodized aluminum
- Insert - Clear anodized aluminum

## INSTALLATION

- Wall Mount
- Door Mount
- Workstation Mount
- Desk Stand

The Magnetic Signs can be attached to a flat substrate with double sided tape and silicone if needed.

## HOW TO OPERATE

Simply use the custom removal tool to the release the Insert you wish to remove. The Insert will release from within the frame.

To replace, simply slip the Insert into position within the frame.

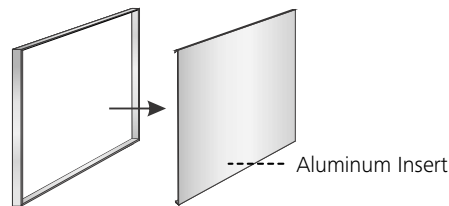

- Access Inserts from the front using the Insert Removal Tool.

## SIZES

The Magnetic Sign Series is flexible in its design, thus offering many sizes and layouts.

Choose from the following insert sizes:

### Insert Height Options:

13/16", 1 5/8", 2 7/16", 3 1/4", 4 1/8", 4 15/16"  
.....increasing in multiples of approx. 13/16" to a maximum single Insert height of 47 1/8"

### Sign Width Options:

8", 10", 12" 14", 16", 18", 20", 24", 30", 35", 40", 45", 50"

Custom widths are available on request

## POSSIBLE USES

- Door Signs
- Personnel Signs
- Graphic Information
- Room ID
- Wayfinding
- Department ID

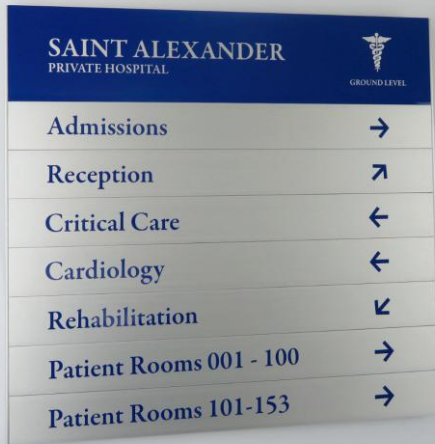



# Cubicle Sign Series

C Channel Signs

- For office screen partitions, wall or desk mount

## C CHANNEL NAMEPLATES

The C Channel Name Plates are part of the Workstation Sign Series.

The C Channel is aluminum with a clear anodized finish.

Optional Inserts for the C Channel are:

- Clear Polycarbonate
- Aluminum Plate

Add vinyl copy directly to the face of the aluminum plate and also the rear of the clear polycarbonate insert.

Alternatively, print your copy and graphics on paper, trim and insert the paper in behind the clear cover.

### Clear Cover Option

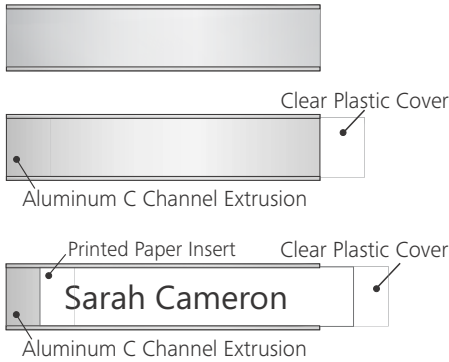

## FINISH

- Frame - The Standard finish is clear anodized aluminum - SNA
- Clear Cover
- Aluminum Plate - SNA

## INSTALLATION

- Cubicle Mount - The Nameplate sign is attached directly to a custom bracket which either slips into the cavity in the workstation screen cap, or over the top of the workstation screen.

Magnetic Tape is also available.

### Aluminum Plate Option

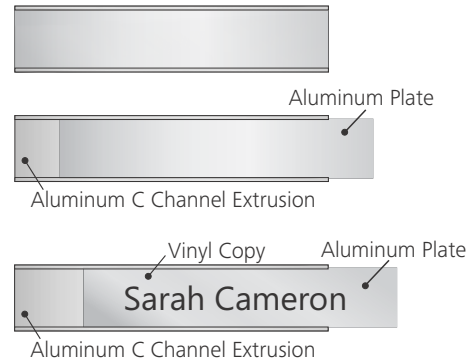

## SIZES

The C Channel Nameplate Signs are available in the following standard sizes:

- Standard C Channel Heights: 13/16", 1 5/8", 2 7/16", 3 1/4", 4 1/8"
- Standard C Channel Widths: 6", 8", 10", 12", 14",

## WORKSTATION BRACKETS

- S Bracket - Shape varies depending on screen system being used.
- U Bracket - Size varies depending on depth of screen being used.

Fabric Pins - 2 Pins attached to the back of the sign that attach to the screen fabric

## HOW TO OPERATE

Clear Cover Option:

- Slide your printed paper under the clear cover.
- Apply vinyl copy to the back of the clear cover.

Aluminum Plate Option:

- Apply vinyl copy directly to the face of the aluminum plate.

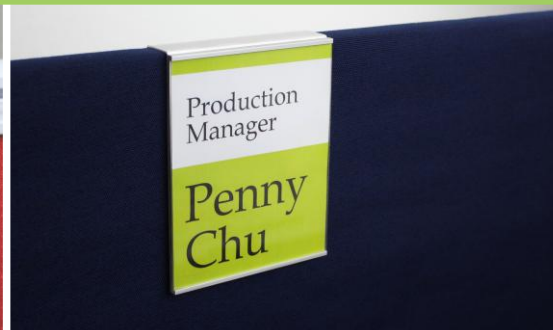

# LETTER & LEDGER INSERT SIGNS

The Letter and Ledger size Cubicle Sign Series is a 3 sided slimline aluminum frame, with a clear plastic cover.

There is open access at the top of the sign where you can insert a piece of printed paper. The paper sits behind the clear cover.

Print your company logo, staff or location name and use the sign for staff ID as well as company branding.

The clear cover also acts as a whiteboard. Simply write on the cover with a Dry Erase Board marker. Remove with a DEB duster or smooth cloth.

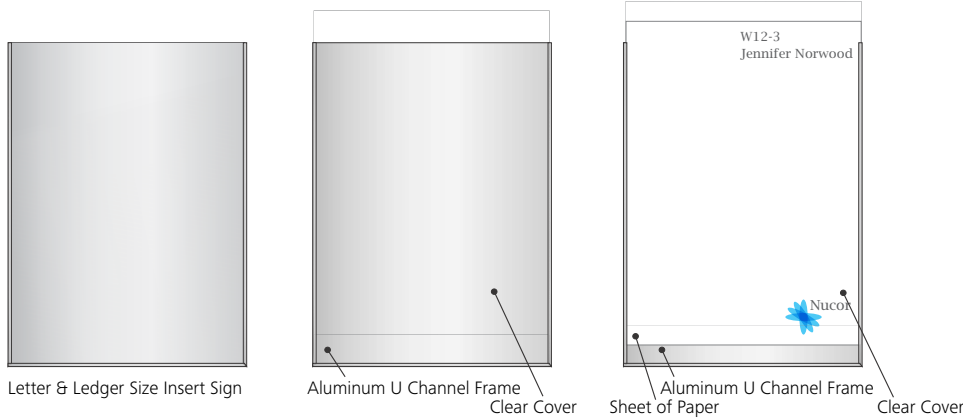

## FINISH

- Frame - The Standard finish is clear anodized aluminum.
- Cover - Clear Plastic

## INSTALLATION

- Cubicle Mount - This sign can be attached to a custom bracket and fixed directly to a cubicle or workstation screen.
- Wall Mount - Signs can be attached to the flat substrate with double-stick tape and silicone if needed.

Please specify the mounting option you require.

## SIZES

The Letter and Ledger Insert Sign Series is available in the following standard sizes:

- Letter Size Portrait
- Letter Size Landscape
- Ledger Size Portrait
- Ledger Size Landscape

Custom Sizes are available on request. Please nominate the size you require.

## POSSIBLE USES

- Messages
- Patient Information
- Notes
- Staff Information
- Meeting Information
- Workstation Signage

## HOW TO OPERATE

Slide your printed sheet of letter size paper in behind the clear cover.

If used as a Dry Erase Board, only use a DEB marker to write on the clear cover. Use a clean cloth or Dry Erase Board eraser to remove marker.

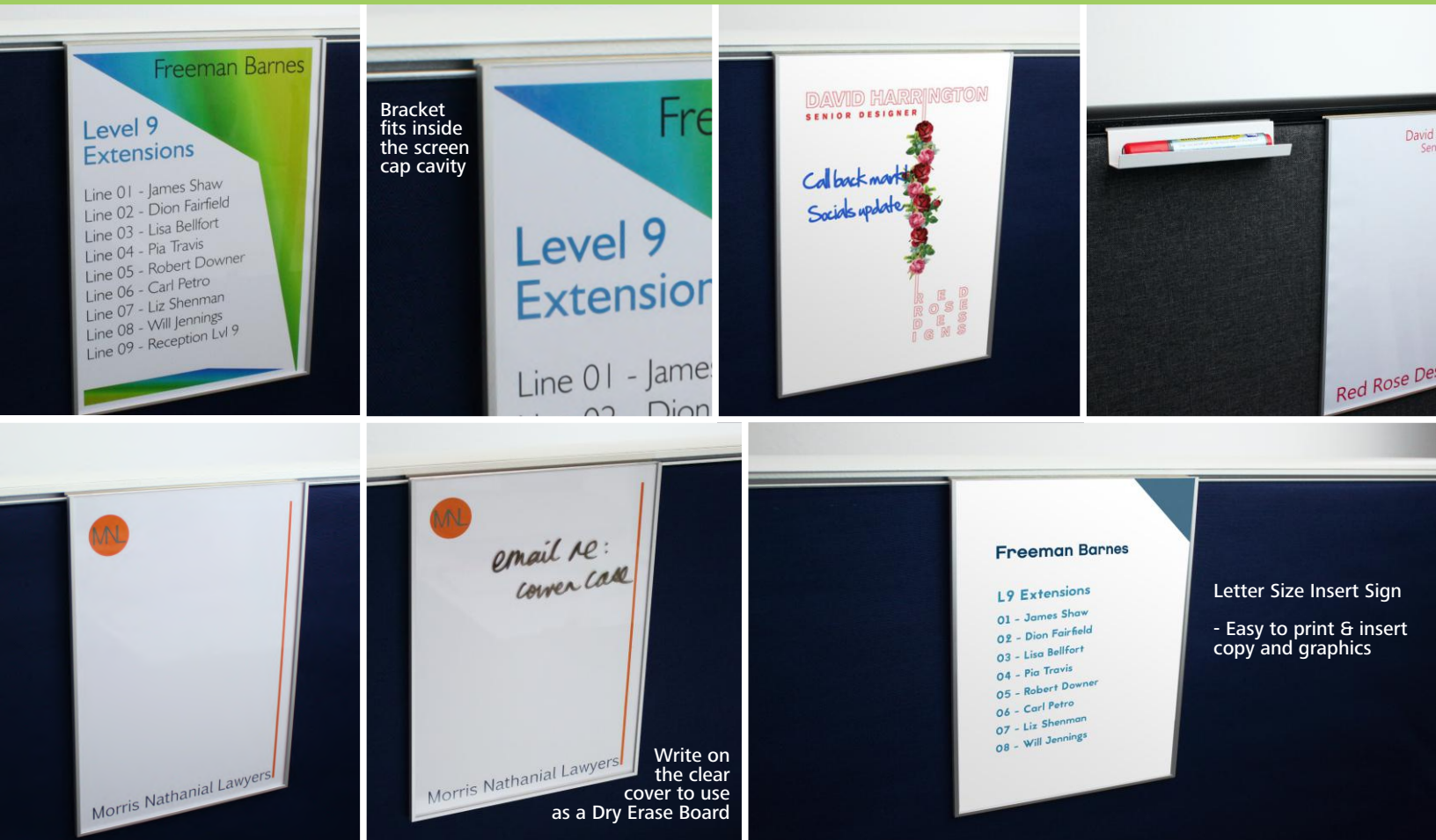

## CUBICLE SIGN SERIES

The Cubicle Sign Series is designed to make updating names, labels, copy and graphics easy, cost effective, time efficient and streamlined. This system has been designed with the end user in mind.

Simply insert the printed or paper graphics in behind the clear cover, or add your vinyl copy directly to the aluminum plate.

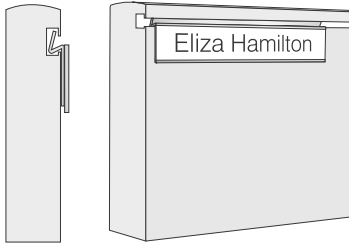

**S Bracket**

This Bracket can sit inside the groove within the screen system cap.

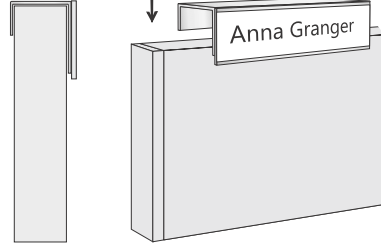

**U Bracket**

This Bracket sit over the top of the cubicle screen.

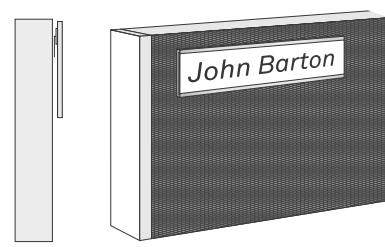

**Pin Mount**

Two custom pins attached to the back of the sign to allow mounting to the fabric

## C CHANNEL NAMEPLATES

### SIZES

#### C Channel - Heights

13/16", 1 5/8", 2 7/16" 3 1/4", 4 1/8"

#### C Channel - Widths

6", 8", 10", 12", 14"

1. Choose the sign size you require
2. Choose the bracket style, S, U or Pins

**NOTE:** Systech will require details of the chosen screen system or a sample prior to manufacture, as all screen shapes, and dimensions vary.

Other sizes available on request.

### OPTIONS FOR INSERTS

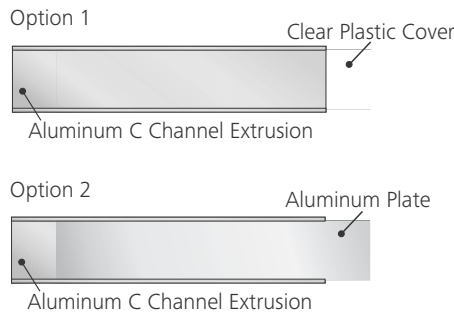

### MOUNTING OPTIONS

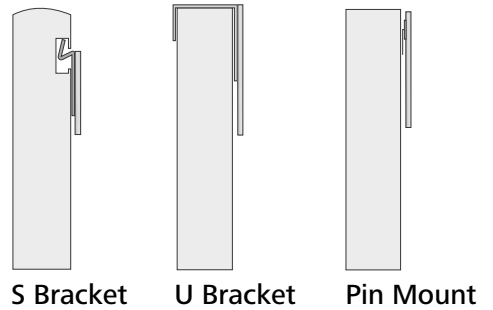

Choose an options above. Your chosen mounting option will be attached to your preferred sign.

Each option will vary depending on the chosen screen system.

## LETTER & LEDGER INSERT SIGNS

### SIZES

- Letter - 8 1/2" W X 11" H - Portrait
- Letter - 11" W X 8 1/2" H - Landscape
- Legal - 8 1/2" W X 14" H - Portrait
- Legal - 14" W X 8 1/2" H - Landscape

1. Choose the size you require
2. Choose the bracket style, S or U

Other sizes available on request.

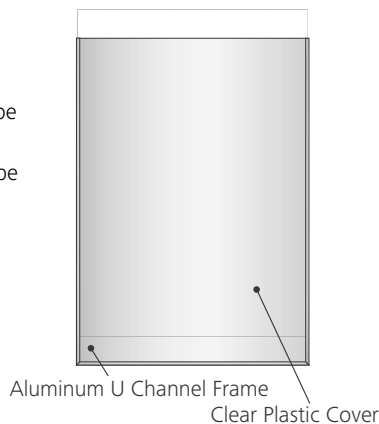

### BRACKET OPTIONS

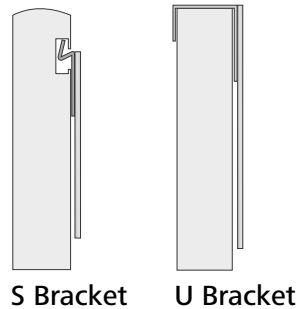

Choose an options above. Your chosen mounting option will be attached to your preferred sign.

Each option will vary depending on the chosen screen system.

## WALL MOUNT INSTALLATION

All sign types included in this brochure can be wall mounted as an alternative installation method. Wall mounted signs are supplied without the workstation bracket. Please nominate wall mount installation if you do not require a workstation bracket.

# Dry Erase Board Sign Series

Mount to various substrates. Can be combined  
with our other interior signage systems

## DRY ERASE BOARD SERIES

The Dry Erase Board Sign Series is a versatile unit made from a DEB that is encased by a slim aluminum frame. There are a few designs, which offer both a fixed and a removable Dry Erase Board giving the user added flexibility.

The unit is available with a 4 sided frame for a permanently fixed DEB or a 3 sided frame to enable the DEB to be removed from if needed.

The 4 sided frame design also has the option to add a Paper Hanger Series at the top of the frame, this enables the user to add paper notes or messages if required.

### 3 Standard Models are Offered:

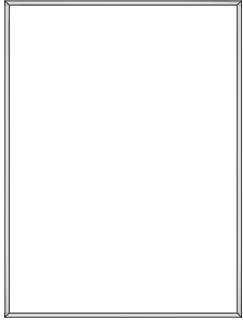

DEB with a 4 Sided Frame  
- DEB is fixed

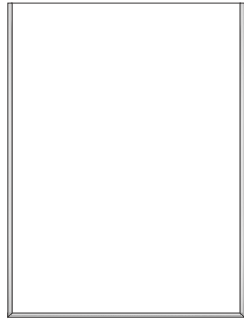

DEB with a 3 Sided Frame  
- DEB is removeable

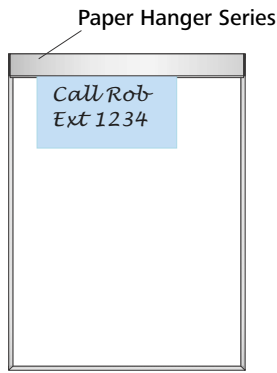

DEB with a 4 Sided Frame  
- With Paper Hanger Added

## FINISH

- Frame - The Standard finish is clear anodized aluminum.
- Dry Erase Board - Gloss White

## INSTALLATION

- Wall Mount - DEB Signs can be attached to the flat substrate with double sided tape and silicone if needed.
- Workstation Mount - The DEB can also be attached to a custom bracket and fixed directly to a cubicle / workstation screen.

## SIZES

The Dry Erase Board Sign Series is available in the following standard sizes:

- 8 1/2" W X 11" H - Letter Size Portrait
- 11" W X 8 1/2" H - Letter Size Landscape
- 11" W X 17" H - Ledger Size Portrait
- 17" W X 11" H - Ledger Size Landscape

Custom Sizes are available on request. Please nominate the size you require.

## POSSIBLE USES

- Messages
- Patient Information
- Notes
- Staff Information
- Meeting Information
- Workstation Signage

## HOW TO OPERATE

- Only use a Dry Erase Board marker to write on these signs.
- Use a clean cloth or DEB eraser to remove the marker.

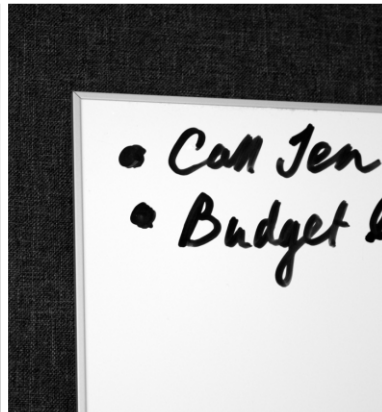
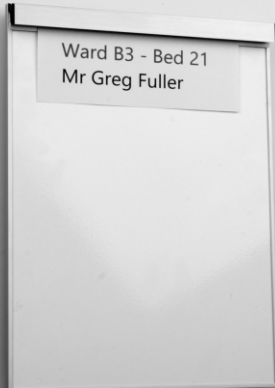
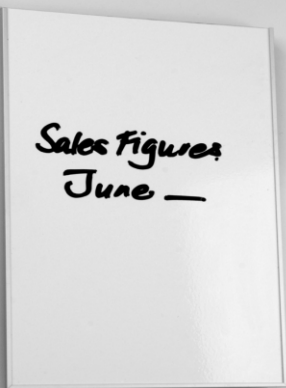
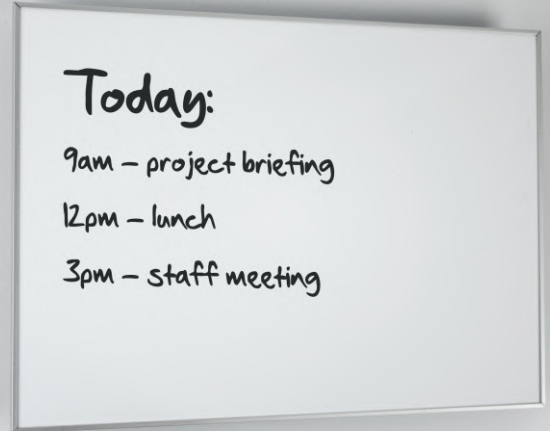

# C Channel Sign Series

Mount to various substrates. Can be combined with our other interior signage systems

## C CHANNEL NAMEPLATES

C Channel Sign Series is a simple, C Channel extrusion into which you can slide various Inserts.

Optional Inserts for the C Channel are:

- Clear Polycarbonate
- Aluminum Plate

Simply print your copy and graphics on paper, trim and insert the paper in behind the clear cover. Alternatively, you can add vinyl copy to the rear of the clear cover.

Alternatively, add vinyl copy directly to the face of the aluminum plate and also the

## FINISH

- Frame - The Standard finish is clear anodized aluminum - SNA
- Clear Cover
- Aluminum Plate - SNA

## MOUNTING & INSTALLATION

- Wall mount
- Door mount
- Desk stand
- Cubicle bracket (Refer to Section R)
- Double stick tape
- Silicone adhesive
- Magnetic Tape is also available.

## SIZES

The C Channel Nameplate Signs are available in the following standard sizes:

### • Standard C Channel Heights:

- 13/16" High
- 1 5/8" High
- 2 7/16" High
- 3 1/4" High
- 4 1/8" High



### • Standard C Channel Widths:

- 4", 5", 6", 7", 8", 9", 10", 12", 14", 16", 18"

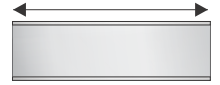

### Clear Cover Option

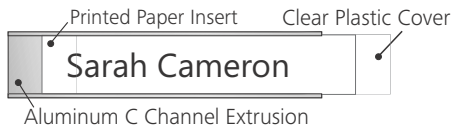
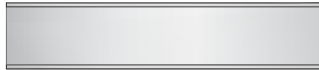

### Aluminum Plate Option

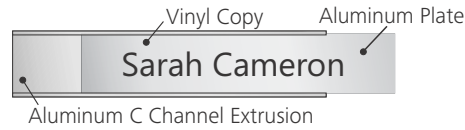

## HOW TO OPERATE

### Clear Cover Option:

- Slide your printed paper under the clear cover.
- Apply vinyl copy to the back of the clear cover.

### Aluminum Plate Option:

- Apply vinyl copy directly to the face of the aluminum plate.





# Contact:

Systech Signage Technology

T: 1800 807 1931

F: 1800 871 1346

E: [info@systech-signage.com](mailto:info@systech-signage.com)

W: [www.systech-signage.com](http://www.systech-signage.com)

We have distributors across the USA.

Please contact us directly for a Systech dealer nearest you.

Distribution: USA, Canada, Asia, Australia and New Zealand