

Cubicle Sign Series

Signs for Cubicles and Workstation Screen Systems

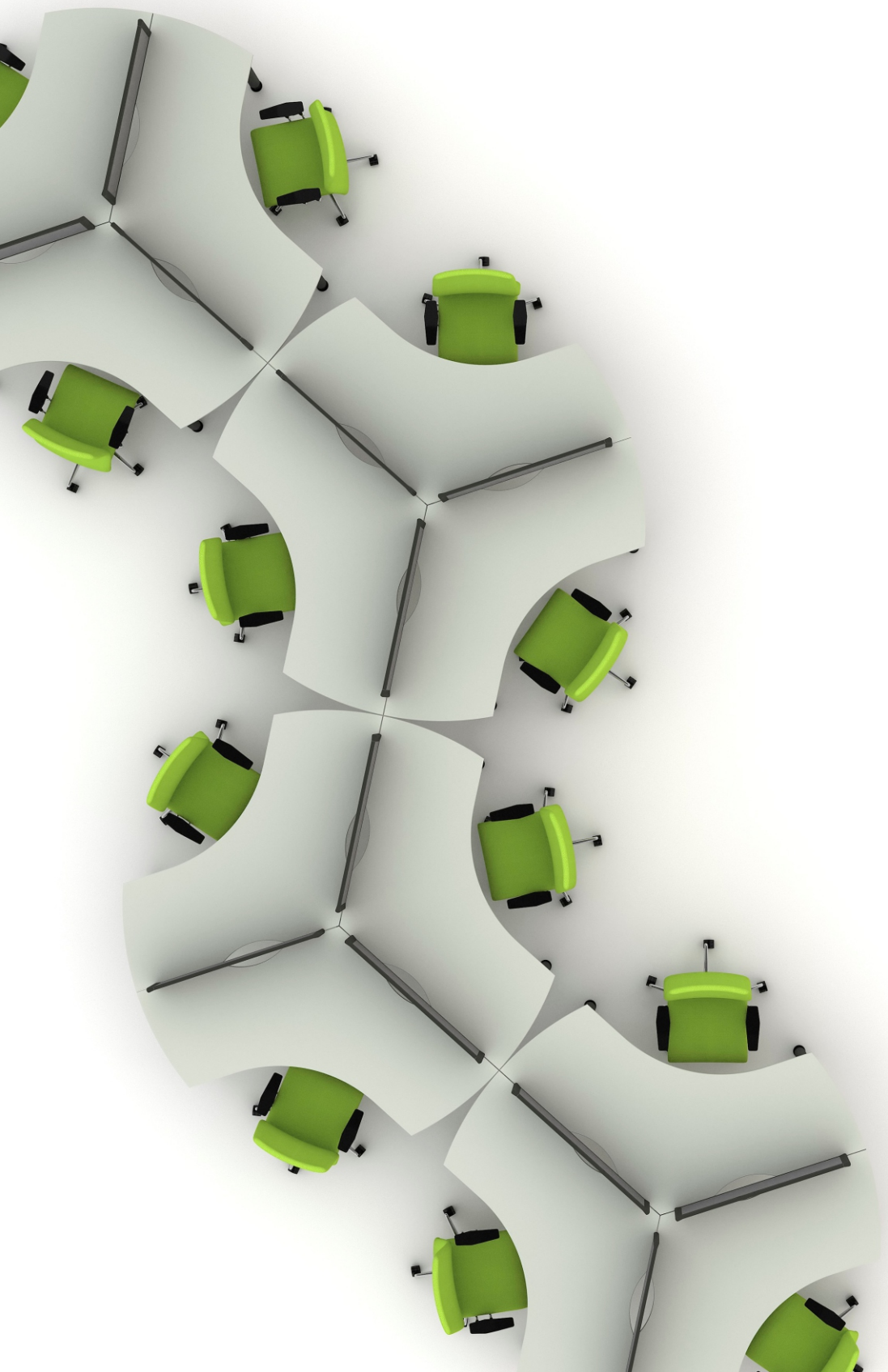

C CHANNEL NAMEPLATES

The C Channel Name Plates are part of the Workstation Sign Series.

The C Channel is aluminum with a clear anodized finish.

Optional Inserts for the Channel are:

- Clear Polycarbonate
- Aluminum Plate

Add vinyl copy directly to the face of the aluminum plate and also the rear of the clear polycarbonate insert.

Alternatively, print your copy and graphics on paper, trim and insert the paper in behind the clear cover.

Clear Cover Option

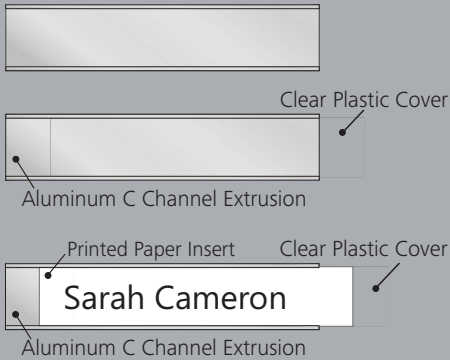

FINISH

- Frame - The Standard finish is clear anodized aluminum - SNA
- Clear Cover
- Aluminum Plate - SNA

INSTALLATION

- Cubicle Mount - The Nameplate sign is attached directly to a custom bracket which either slips into the cavity in the workstation screen cap, or over the top of the workstation screen.

Magnetic Tape is also available.

Aluminum Plate Option

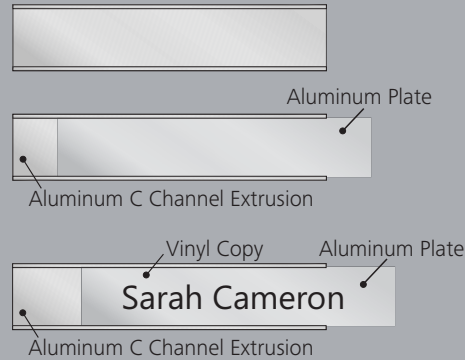

SIZES

The C Channel Nameplate Signs are available in the following standard sizes:

- Standard C Channel Heights: 13/16", 1 5/8", 2 7/16", 3 1/4", 4 1/8"
- Standard C Channel Widths: 6", 8", 10", 12", 14",

WORKSTATION MOUNTS

- S Bracket - Shape varies depending on screen system being used.
- U Bracket - Size varies depending on depth of screen being used.
- Pin Mount - 2 Pins attached to the back that are inserted into the screen fabric.

HOW TO OPERATE

Clear Cover Option:

- Slide your printed paper under the clear cover.
- Apply vinyl copy to the back of the clear cover.

Aluminum Plate Option:

- Apply vinyl copy directly to the face of the aluminum plate.

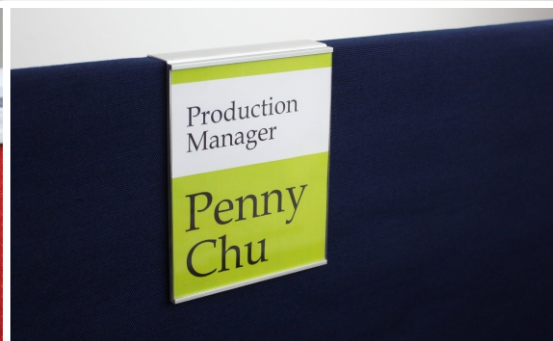

All sign types included in this brochure can be wall mounted as an alternative option. Please nominate wall mount installation if you do not require a workstation bracket.

LETTER & LEDGER INSERT SIGNS

The Letter and Ledger size Cubicle Sign Series is a 3 sided slimline aluminum frame, with a clear plastic cover.

There is open access at the top of the sign where you can insert a piece of printed paper. The paper sits behind the clear cover.

Print your company logo, staff or location name and use the sign for staff ID as well as company branding.

The clear cover also acts as a whiteboard. Simply write on the cover with a Dry Erase Board marker. Remove with a DEB duster or smooth cloth.

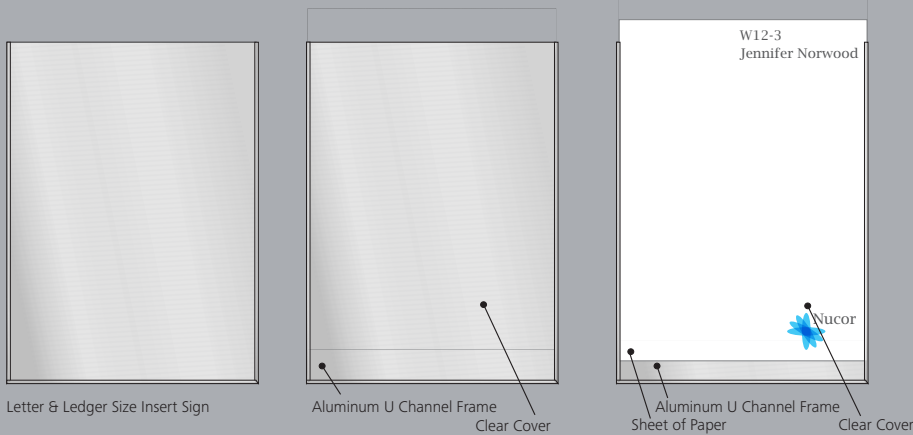

FINISH

- Frame - The Standard finish is clear anodized aluminum.
- Cover - Clear Plastic

INSTALLATION

- Cubicle Mount - This sign can be attached to a custom bracket and fixed directly to a cubicle or workstation screen.
- Wall Mount - Signs can be attached to the flat substrate with double-stick tape and silicone if needed.

Please specify the mounting option you require.

SIZES

The Letter and Ledger Insert Sign Series is available in the following standard sizes:

- Letter Size Portrait
- Letter Size Landscape
- Ledger Size Portrait
- Ledger Size Landscape

Custom Sizes are available on request. Please nominate the size you require.

POSSIBLE USES

- Messages
- Notes
- Meeting Information
- Patient Information
- Staff Information
- Workstation Signage

HOW TO OPERATE

Slide your printed sheet of letter size paper in behind the clear cover.

If used as a Dry Erase Board, only use a DEB marker to write on the clear cover. Use a clean cloth or Dry Erase Board eraser to remove marker.

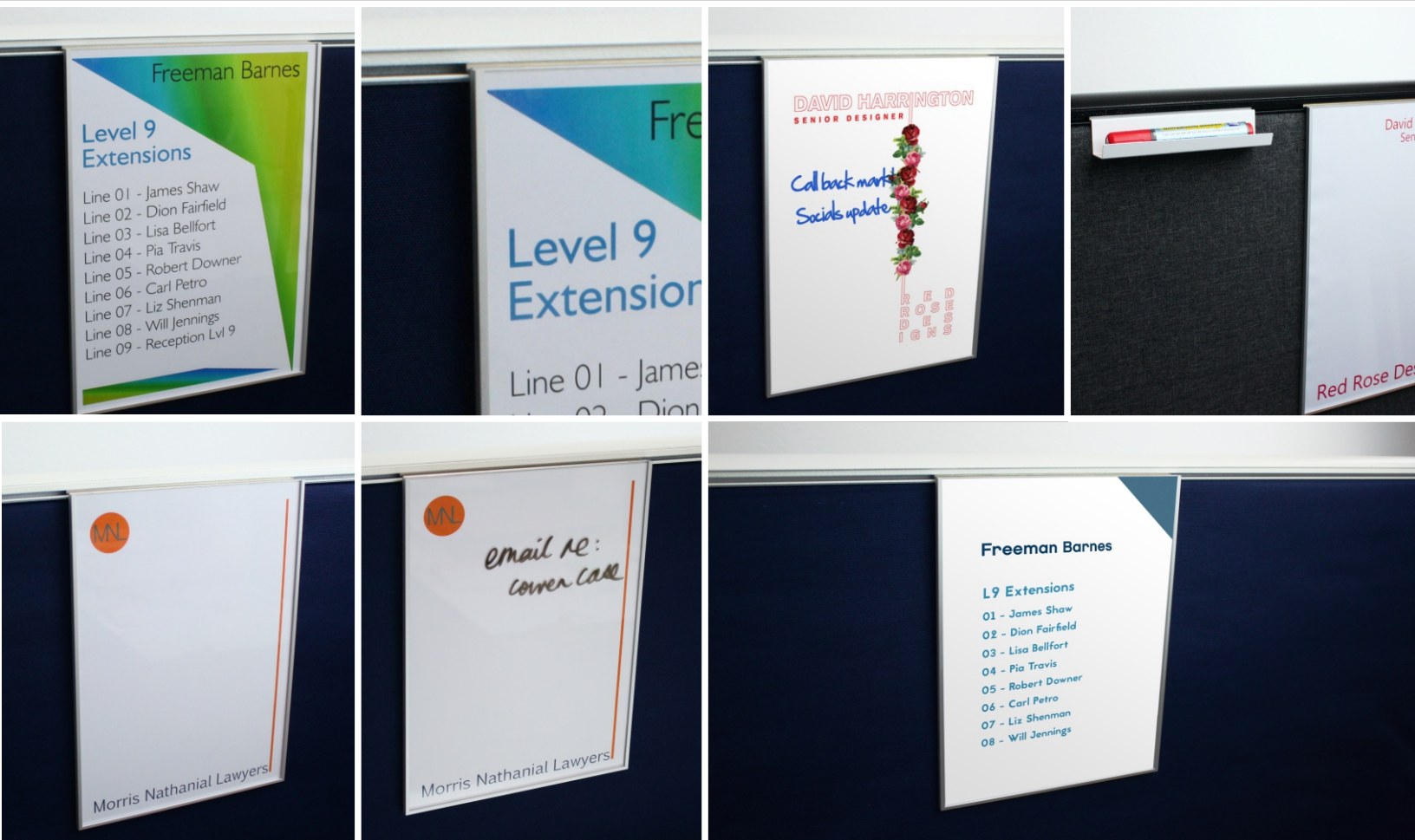

All sign types included in this brochure can be wall mounted as an alternative option. Please nominate wall mount installation if you do not require a workstation bracket.

CUBICLE SIGN SERIES

The Cubicle Sign Series is designed to make updating names, labels, copy and graphics easy, cost effective, time efficient and streamlined. This system has been designed with the end user in mind.

Simply insert the printed or paper graphics behind the clear cover, or add your vinyl copy directly to the aluminum plate.

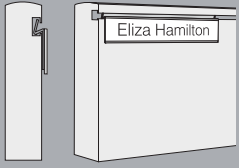

S Bracket

This Bracket can sit inside the groove within the screen system cap.

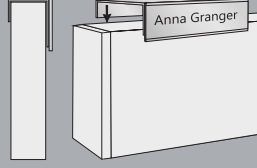

U Bracket

This Bracket can sit over the top of the screen system cap.

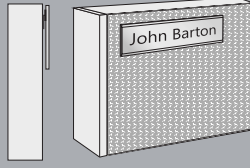

Pin Mount

Two custom pins attached to the back of the sign allow mounting to the fabric

BRACKET DETAILS

Systech manufacture brackets to suit each type and size of cubicle or workstation screen.

Whether its an S or U shaped bracket or Pin Mount. We will manufacture the bracket to fit the desired system.

Details and dimensions may be required when you request pricing, or prior to manufacture.

All Signs are supplied with a bracket unless otherwise specified.

C CHANNEL NAMEPLATES

SIZES

C Channel - Heights

13/16", 1 5/8", 2 7/16" 3 1/4", 4 1/8"

C Channel - Widths

6", 8", 10", 12", 14"

1. Choose the sign size you require
2. Choose the bracket style, S or U or Pin

NOTE: Systech will require details of the chosen screen system or a sample prior to manufacture, as all screen shapes, and dimensions vary.

Other sizes available on request.

OPTIONS FOR INSERTS

Option 1



Option 2

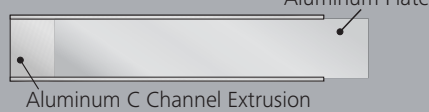

BRACKET OPTIONS

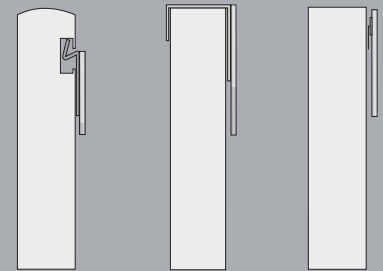

S Bracket U Bracket Pin Mount

Choose an S shaped bracket, a U shaped bracket or Pin Mount for your preferred sign.

Each bracket will vary depending on the chosen screen system.

LETTER & LEDGER INSERT SIGNS

SIZES

- Letter - 8 1/2" W X 11" H - Portrait
- Letter - 11" W X 8 1/2" H - Landscape
- Legal - 8 1/2" W X 14" H - Portrait
- Legal - 14" W X 8 1/2" H - Landscape

1. Choose the size you require
2. Choose the bracket style, S or U

Other sizes available on request.

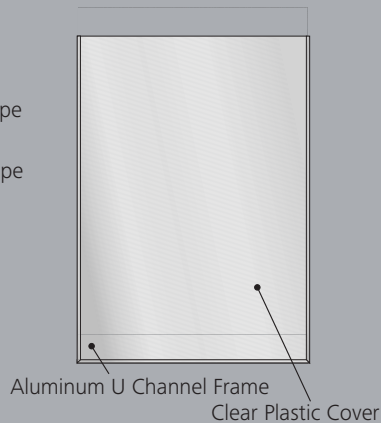

BRACKET OPTIONS

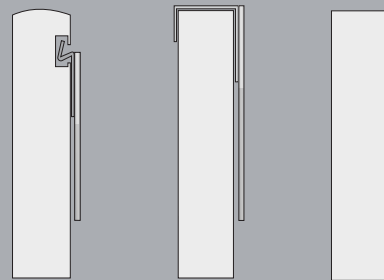

S Bracket U Bracket Pin Mount

Choose an S shaped bracket, a U shaped bracket or Pin Mount for your preferred sign.

Each bracket will vary depending on the chosen screen system.

WALL MOUNT INSTALLATION

All sign types included in this brochure can be wall mounted as an alternative installation method. Wall mounted signs are supplied without the workstation bracket. Please nominate wall mount installation if you do not require a workstation bracket.

CONTACT DETAILS

Systech Signage Technology
 T. 800 807 1931
 F. 800 871 1346
 E: info@systech-signage.com
 W. www.systech-signage.com

